

AUTO CRIB-IT™

INSTRUCTION MANUAL

For

MODELS AC-14 and AC-17



Model AC-14



Model AC-17

AUTO CRIB-IT™ Description

CONGRATULATIONS on your purchase of the *AUTO CRIB-IT™*!... the easiest and quickest vehicle stabilization tool on the market! Lightweight and portable, this tool can be positioned and operated to automatically extend and stabilize vehicles in seconds. Use it for auto-extrication and other stabilization operations, up to a maximum load of 2000 lbs for the AC-14 and 2800 lbs for the AC-17! The *AUTO CRIB-IT* is patented and utilizes gas-spring actuated extender plates that automatically rise to engage the working material and lock into place. Because the *AUTO CRIB-IT* is gas-spring-loaded, it will self-adjust upward and lock as weight is removed from the vehicle. The *AUTO CRIB-IT* can also be placed completely under and parallel to rocker panels to avoid trip hazards. Because the tool is made from high-strength aluminum and other metal parts, the *AUTO CRIB-IT* is easily decontaminated. Its super compact design makes it easy to stow and can free up room for other vital equipment.

The components of the *AUTO CRIB-IT* are shown below for each model. Refer to these terms throughout this instruction manual.

MODEL AC-14

- A. Channel Base (P/N 2C0903-1)
- B. Fixed Extender Plate (P/N 2C0904-1)
- C. Moveable Extender Plate (P/N 2C0905-1)
- D. Hinge (P/N 2C0913-1)
- E. Angle Supports
- F. Slide Bracket Pin (P/N 2C0906-1)
- G. Pin (P/N 2C0915-1)
- H. Gas Piston Spring Kit (P/N C16-29759)
- I. Handle (P/N 2C0912-1)
- J. Lock (P/N PHT1820A26)
- K. Bottom Grip Surface (P/N PHT6970T151)

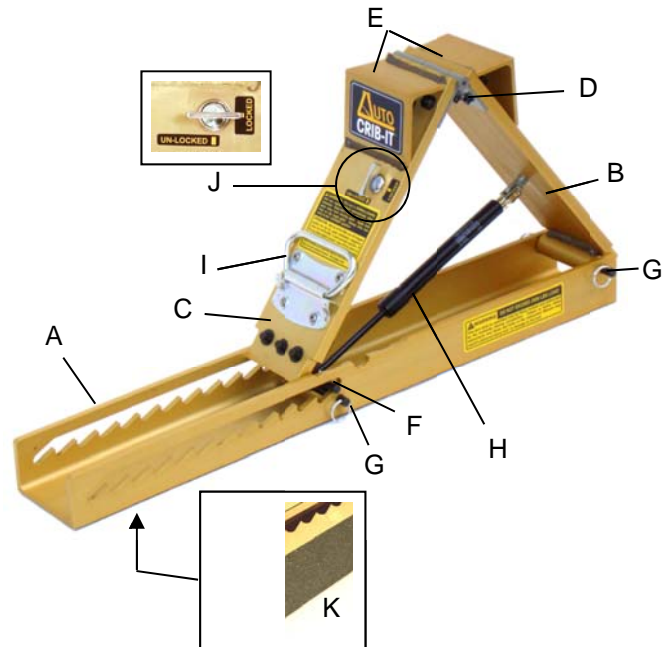

MODEL AC-17

- A. Channel Base (P/N 2C0931-1)
- B. Fixed Extender Plate (P/N 2C0932-1)
- C. Moveable Extender Plate (P/N 2C0933-1)
- D. Hinge (P/N 2C0913-1)
- E. Angle Supports
- F. Slide Bracket Pin (P/N 2C0934-1)
- G. Pin (P/N 2C0935-1)
- H. Gas Piston Spring Kit (P/N C16-29760)
- I. Handle (P/N 2C0912-1)
- J. Lock (P/N PHT1820A26)
- K. Bottom Grip Surface (P/N PHT6970T153)

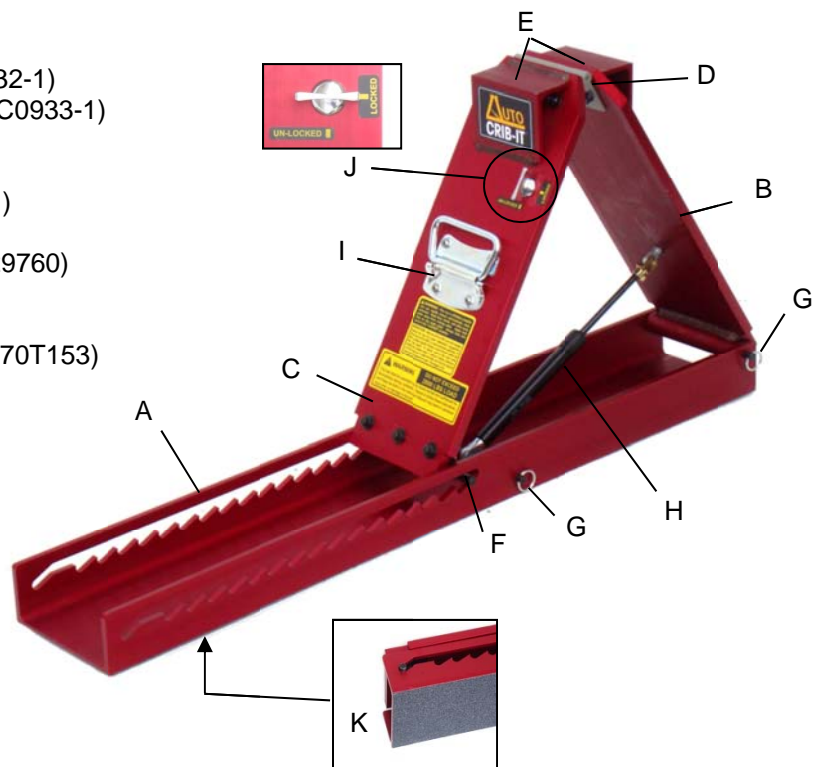

General Safety Information

The *AUTO CRIB-IT* is designed to provide safe operation. All users should read and be thoroughly familiar with the operating instructions and safety precautions contained in this manual. Operator safety depends on users being properly trained by the Authority having jurisdiction and using the tool for the purpose intended. The following safety precautions must be observed at all times. **FAILURE TO DO SO COULD RESULT IN PERSONAL INJURY, DAMAGE TO PROPERTY AND/ OR EQUIPMENT:**

- ◆ The *AUTO CRIB-IT*[™] shall only be operated by persons authorized by the Authority Having Jurisdiction.
- ◆ Personal protective equipment (PPE) shall be worn as directed by the Authority Having Jurisdiction. At a minimum, this should include gloves, helmet, eye protection, steel-toed footwear, and body protection, such as turnout gear.
- ◆ This tool is SPRING-LOADED and can rapidly extend automatically when unlocked. Keep face, hands, and other body parts away from moving parts.
- ◆ DO NOT EXCEED MAXIMUM LOAD RATINGS (AC-14: 2000 LBS., AC-17: 2800 LBS.)
- ◆ Apply load ONLY to the top Angle Supports
- ◆ Prior to use, inspect all *AUTO CRIB-IT*[™] components for any signs of damage. Do not use damaged equipment.
- ◆ Stow in the retracted position with the *AUTO CRIB-IT* lock engaged.
- ◆ Channel Base bottom grip surface is extremely coarse and can scratch surfaces. Avoid contact with such surfaces to prevent unwanted scratches.
- ◆ Stay alert. Do not operate tool when tired.
- ◆ Use only Factory authorized service parts.

AUTO CRIB-IT Operation

Note: Model AC-14 is used for the following step-by-step instructions which are the same for Model AC-17.

1. Determine the engagement point(s) on the vehicle for proper stabilization.

Minimum starting clearances:

Model AC-14: Approx. 5-3/4 inches

Model AC-17: Approx. 8-1/4 inches

NOTE: Because of the *AUTO CRIB-IT*'s retractable design, you can use engagement points under the rocker panel and on the vehicle's frame.

2. Determine the *AUTO CRIB-IT* orientation for proper stabilization (i.e. perpendicular or parallel to the rocker panel)

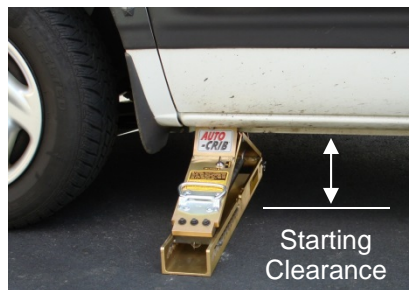

Perpendicular



Parallel

CAUTION: Always stow and carry the *AUTO CRIB-IT* in the locked position



- 3. With the *AUTO CRIB-IT* lock still engaged, tool under the vehicle so that when the Angle Supports will contact the desired engagement point.



position the extended,

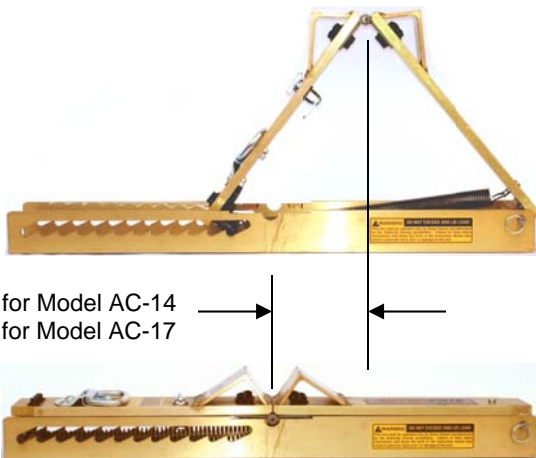

Approx. 5 inches for Model AC-14 and 9 inches for Model AC-17



- 4. Disengage *AUTO CRIB-IT* Lock by turning the knob Clockwise as shown below. Be sure to hold the top plates down against the Channel Base to prevent unintended automatic extension.

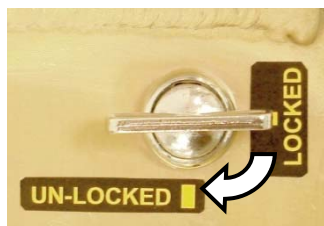



The Top Plates are **SPRING-LOADED** and can rapidly extend automatically when unlocked. Keep face, hands, and other body parts away from moving parts.

5. Start automatic operation of the *AUTO CRIB-IT* by slightly lifting the top plates. **CAUTION: DO NOT lift from above the Angle Supports.** The spring action will cause the tool to rise and the Slide Pin to ratchet across the slots in the Channel Base until the Angle Supports contact the engagement point. The slide pin and channel slot provides no-back locking of the *AUTO CRIB-IT*.



Correct



Wrong



HINT: Raising the vehicle suspension manually will bring the *AUTO CRIB-IT* to a higher notch to provide tighter engagement.

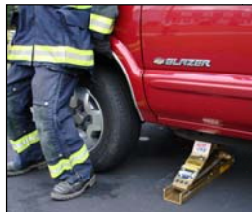

6. Inspect the *AUTO CRIB-IT* engagement to ensure it is secure and has properly stabilized the vehicle.

NOTE: As weight is removed from the vehicle, the vehicle's suspension may cause its body to lift. In this circumstance, the *AUTO CRIB-IT* will automatically rise with the body and lock to the new height (provided the height is within the maximum extension of the tool).



WARNING

DO NOT EXCEED MAXIMUM LOAD RATINGS

Model AC-14: 2,000 LBS. MAX LOAD

Model AC-17: 2,800 LBS. MAX LOAD

Failure to do so may result in breakage of components and may cause serious personal injury, damage to property and/or equipment.

TO REMOVE AUTO CRIB-IT...

7. Hold the *AUTO CRIB-IT* handle down to prevent further extension and remove the applied load from the Angle Supports.
8. Once the load is removed, lift the *AUTO CRIB-IT* handle upward to clear the slide pin from the slots in the Channel Base and pull outward (toward the front of the *AUTO CRIB-IT*), while pushing down on the Moveable Plate with your other hand at the same time. HINT: Apply toe pressure to the front of the Channel Base to prevent the entire tool from moving.



NOTE: Avoid getting debris in between the Angle Supports which could get jammed and prevent retraction.

9. Make sure Top Plates are all the way down and resting on the Channel Base. Re-engage *AUTO CRIB-IT* Lock by turning the knob Counter-Clockwise as shown below. Test by pulling up on the Top Plates to ensure the lock is properly engaged.

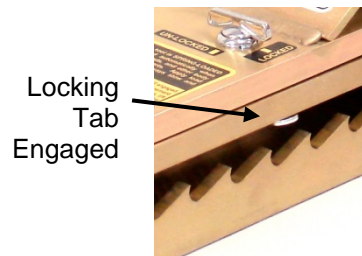
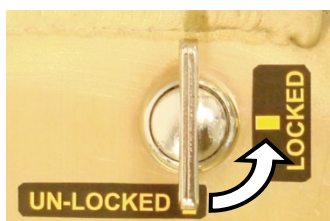

⚠ CAUTION

Make sure that the ¼-Turn Lock is in the UN-LOCKED position when retracting the *AUTO CRIB-IT*. Failure to comply will not allow the Top Plates to become fully retracted and can cause the Locking Tab to become loaded and bent. If the Tab becomes bent, use pliers to straighten so that it properly engages the upper part of the Channel slot when in the LOCKED position.

When Retracting

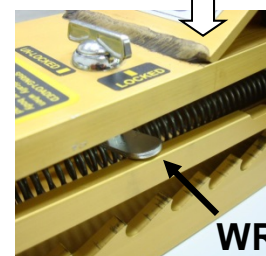

10. Remove the *AUTO CRIB-IT* from underneath the vehicle. Stow using the Velcro strap that is provided to prevent accidental release and extension.



RAISING THE AUTO CRIB-IT STARTING HEIGHT...

If maximum extension of the *AUTO CRIB-IT* is reached before sufficiently engaging and stabilizing the vehicle, the starting height of the *AUTO CRIB-IT* may be raised by using proper block cribbing methods. At a minimum, the *AUTO CRIB-IT* Channel Base must engage the block cribbing at three (3) points... One at each end and one in the center as shown below:



Perpendicular



Parallel

Maintenance

Proper care and maintenance of the *AUTO CRIB-IT* is necessary to ensure long tool life and safe operation.

Interval	Check	Instructions
After Each Use	Make sure all fasteners are tight	Tighten as necessary. Top Hinge Bolts (x8): 30-40 Foot-Pounds Slide Pin Bolts (x3): 30-40 Foot-Pounds Handle Screws (x4): 40-50 Inch-Pounds ¼-Turn Lock Hex Nut (x1): 65-75 Inch-Pounds ¼ Turn Lock Cam Screw (x1): 10-15 Inch-Pounds
	Make sure <i>AUTO CRIB-IT</i> locking mechanism for stowing is engaging properly	Engage <i>AUTO CRIB-IT</i> Lock and attempt to lift top plates. Top plates should not be able to lift.
	Check for bent, damaged or cracked parts.	Replace parts as necessary. NOTE: A bent Slide Pin or Fixed Pin would indicate that the <i>AUTO CRIB-IT</i> was overloaded.
Monthly	Check for smooth automatic operation	Apply WD-40 (or equivalent) to slide pin, fixed pin, channel base slots, and hinge.
Annually	Check for sufficient spring action	Replace gas spring piston assembly as necessary.

Troubleshooting

Problem	Possible Cause	Solution
Extender Plates will not rise automatically	Maximum extension has been reached	Use block cribbing underneath the channel base to raise the AUTO CRIB-IT starting height. Ensure block cribbing supports the channel base at a minimum of three points along its length (each end and in the center). See section on "Raising AUTO CRIB-IT Starting Height".
	Moving parts are dry and require lubrication	Apply WD-40 generously to slide pin, fixed pin, channel base slots, and hinge.
	Insufficient gas-spring pressure	Replace gas spring assembly.
	Parts are damaged	Determine damaged parts and replace as necessary. NOTE: A bent Slide Pin or Fixed Pin would indicate that the <i>AUTO CRIB-IT</i> was overloaded.
Extender Plates will not retract.	Load is still applied to the <i>AUTO CRIB-IT</i>	See instructions on removing <i>AUTO CRIB-IT</i>
	Slide pin is still engaged in channel base slot	See instructions on removing <i>AUTO CRIB-IT</i>
	Material or debris is lodged in between Angle Supports	Remove material or debris from Angle Supports. See instructions on removing <i>AUTO CRIB-IT</i>

If the above does not correct problem, contact your authorized *AUTO CRIB-IT* Dealer or the Factory.

Replacement Parts: Replacement parts for *the AUTO CRIB-IT* can be obtained from your authorized *AUTO CRIB-IT* Dealer or by contacting the Factory.

Specifications

	Model AC-14	Model AC-17
Maximum Load:	2,000 lbs. (8.9 kN)	2,800 lbs. (12.4 kN)
Fully Extended Height:	13 in. (33.0 cm)	17 in. (43.2)
Weight:	14.5 lbs. (6.6 kg)	23.5 lbs. (10.7 kg)
Stowed Dimensions (LxWxH):	28 in. x 4 in. x 2-3/4 in. (71.1 cm x 10.2 cm x 7 cm)	36 in. x 6 in. x 3 in. (91.4 cm x 15.2 cm x 7.6 cm)

NOTE: The Angle Supports add 1-3/8 inches (3.5 cm) to the height at the center

The AUTO CRIB-IT™ is manufactured by:

POWER HAWK® Technologies, Inc.

300 Forge Way, Suite 2, Rockaway, New Jersey 07866 USA
 1-800-PWR-HAWK (1-800-797-4295) or 973-627-4646 Fax: 973-627-4622
www.powerhawk.com

"Power Hawk" is a Registered Trademark of Power Hawk Technologies, Inc.
 "AUTO CRIB-IT" is a Trademark of Power Hawk Technologies, Inc.

WARRANTY

WARRANTY. Power Hawk Technologies, Inc. guarantees the *AUTO CRIB-IT*, parts, equipment and accessories against defects in material and workmanship for a period of one (1) year from the date of purchase by the original purchaser. The identity of the original purchaser and the date of purchase shall be established in each case by the return of the properly completed Warranty Registration Card.

WARRANTY TERMS. The obligations of Power Hawk Technologies, Inc. under this warranty include free replacement of the necessary parts and the shipping costs to return the equipment to the user, provided the inspection of the equipment has proved that the parts were defective at the time of purchase or were improperly designed or manufactured. The warranty inspection can only be performed by a Power Hawk Technologies, Inc. service center or an official Power Hawk Technologies, Inc. factory-trained distributor, and shipping costs to a Power Hawk Technologies, Inc. service center or an official Power Hawk Technologies, Inc. factory-trained distributor will be for purchaser's account. Said warranty shall remain in effect only if (1) such goods are used normally and properly in accordance with Power Hawk Technologies, Inc. instructions as to maintenance and operation, whether given orally or set forth in manuals and instruction sheets furnished by Power Hawk Technologies, Inc. and (2) the purchaser gives prompt notice to Power Hawk Technologies, Inc. of any such defects and preserves and turns over all allegedly defective goods, parts or items.

EXCLUSIONS. This warranty covers all defects in material and workmanship except:

- Any damage occurring during shipments of the goods (for which claims shall be presented to the carrier).
- Normal wear and tear and deterioration.
- Damage caused by abuse, improper use, or corrosion
- Damage caused by repairs performed by persons other than a Power Hawk Technologies, Inc. service center or an official Power Hawk Technologies, Inc. factory-trained distributor, or damage resulting from the use of parts other than genuine Power Hawk Technologies, Inc. parts.
- Damage as a result of improper or neglected reasonable maintenance.

THIS WARRANTY STATED HEREIN IS EXCLUSIVE AND IN LIEU OF ALL OTHER WARRANTIES, WRITTEN OR ORAL, EXPRESS, STATUTORY OR IMPLIED, AND POWERHAWK TECHNOLOGIES, INC. EXPRESSLY DISCLAIMS ANY AND ALL WARRANTIES FOR MERCHANTABILITY, FITNESS, PERFORMANCE OR SUITABILITY FOR A PARTICULAR PURPOSE.

LIMITATION OF DAMAGES. Power Hawk Technologies, Inc.'s obligation under this warranty is limited to repair and/or replacement, at Power Hawk Technologies, Inc.'s option, of any defective Power Hawk Technologies, Inc. tool, part, accessory or item or other manufacturer's tool, part, accessory or item, and under no circumstances, whether due to a breach of any warranty hereunder or any other cause, and whether arising in contract or in tort (including negligence or strict liability) shall Power Hawk Technologies, Inc. be liable for (1) consequential or indirect loss or damage including, but not limited to, loss of profits, loss of production, plant downtime, or liabilities to customers or other third parties, or (2) loss or damage arising out of the sale or contributory negligence of the purchaser, its employees or agents, or any third part, or (3) any special or punitive damages of any nature. If Power Hawk Technologies, Inc. determines, in its sole and final discretion, that the nature of the defect precludes remedy by repair and/or replacement Power Hawk Technologies, Inc. reserves the right to satisfy any warranty obligation by refunding the full purchase price, on return of all defective goods to Power Hawk Technologies, Inc., shipping cost prepaid. Any action for breach of warranty or other action must be commenced within one (1) year after such cause of action arises, except where applicable law would prohibit any such time restriction in bringing of such an action.

NOTICES. For all notices, information and inquiries concerning this warranty or Power Hawk Technologies Inc. service centers and official Power Hawk Technologies, Inc. factory-trained distributors contact:
Power Hawk Technologies, Inc.,
300 Forge Way, Suite 2
Rockaway, New Jersey 07866 USA
Telephone: 973-627-4646 or 1-800-PWR-HAWK (1-800-797-4295)
Fax: 973-627-4622
Email: powerhawk@powerhawk.com